

本系列机箱由塑料面框、前后铝面板、拉伸铝型材侧板、上下盖板组成，并可选配两种提手、安装法兰、底脚等配件。另可按要求进行后面板开孔，上下侧板开散热孔等。

This cabinet series consists of plastic bezel, front and rear panel, aluminum extruder side plate, top and base cover. Handles, flanges, feet and other accessories are available. Holes can be Added as per your request.

序号 CODE	零件名称 NAME OF PARTS	数量 QUANTITY
1	塑料面框 Plastic bezel	2
2	铝面板 Aluminum plate	2
3	铝型材上盖板 Aluminum extruder top cover	1
4	铝型材下盖板 Aluminum below panel	1
5	塑料脚底 Plastic feet	4套(Sets)
6	不锈钢撑脚 Stainless steel supporting feet	2

型号CODE	L × W	A × B	备注REMARK
17-1 17-1B 17-51 19-1	210 × 69	182 × 53	深度(H)可任意定制。 Depth(H) can be customized.
17-2 17-2B 17-52 19-2	258 × 69	231 × 53	
17-3 17-3B 17-53 19-3	210 × 125	182 × 110	
17-4 17-4B 17-54 19-4	258 × 102	231 × 87	
17-62	155 × 85	129 × 71	
17-63	155 × 70	129 × 55	

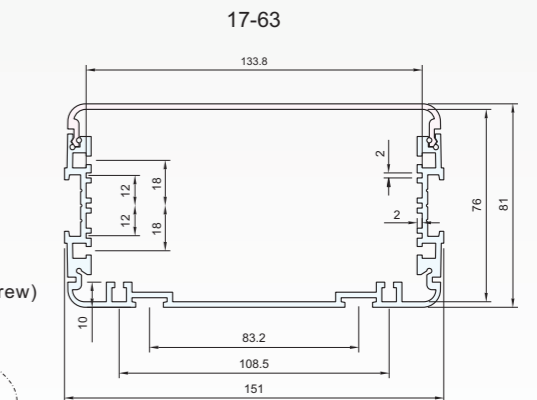
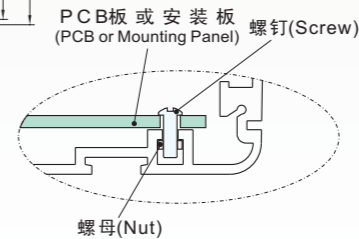
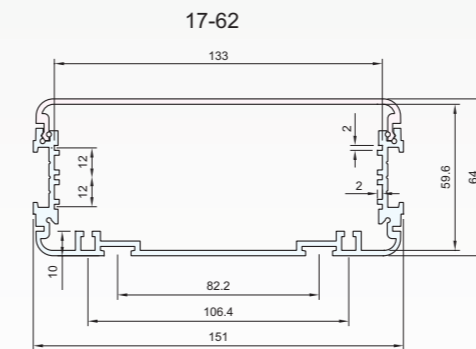
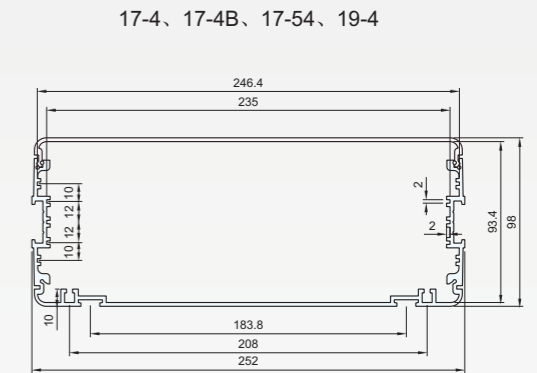
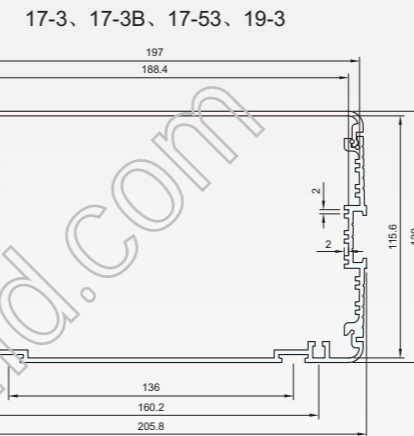
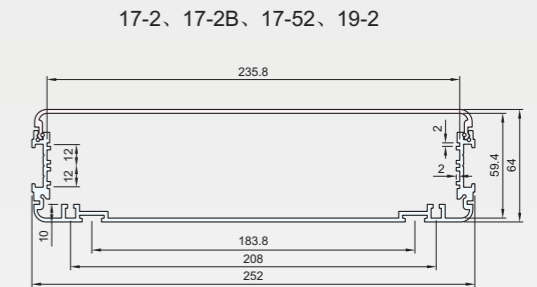
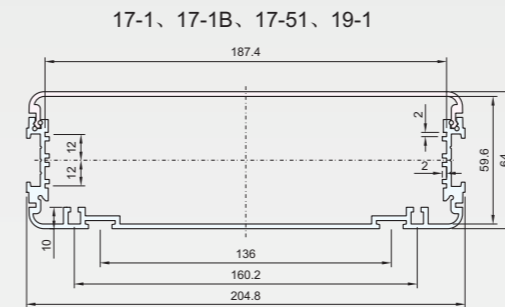
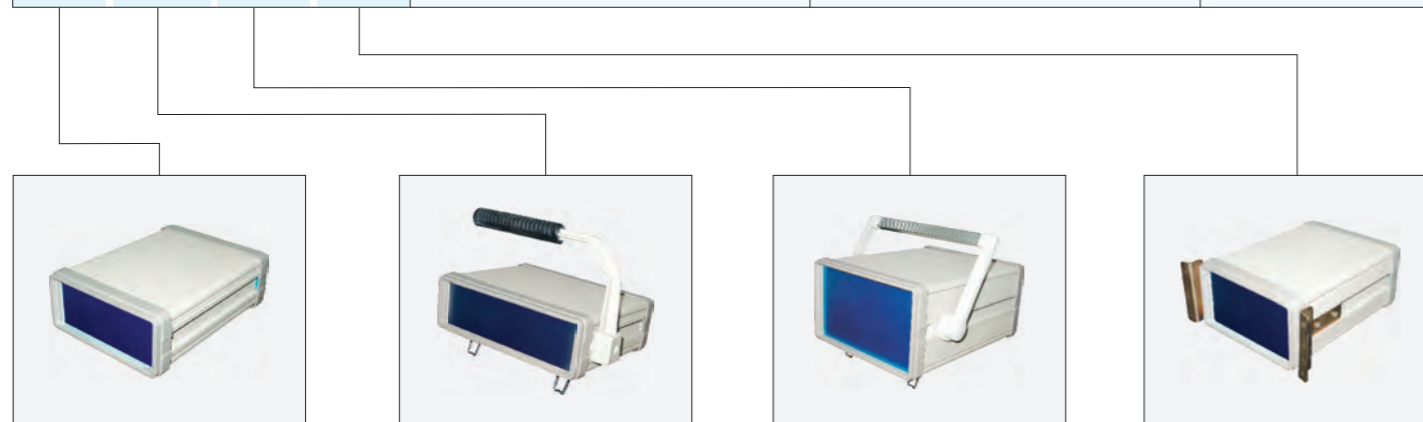

把手使用方法(Using method of handle)

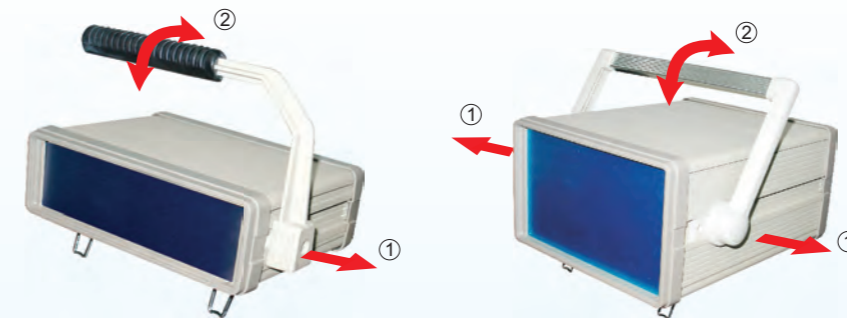

转动提手时，需要先将提手向箭头标示方向拉动，再转动提手。
Pull the handle with the indication of arrowhead, then turn the handle.