

下盖正视图

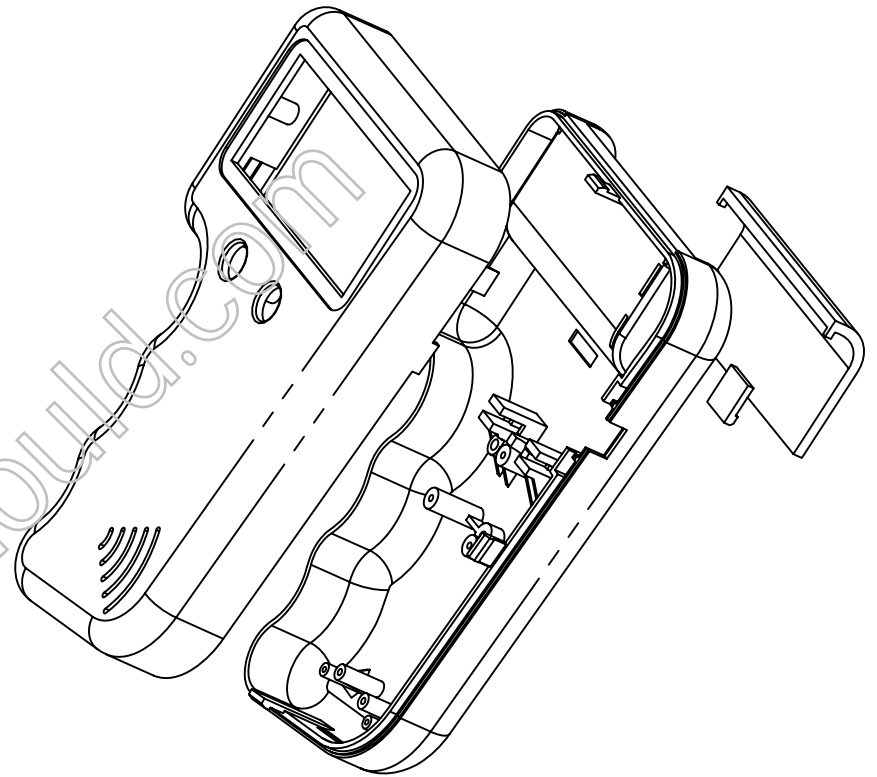

制图 Drawing	审核 Auditing	批准 Confirm	客户名称 Custom Name	材料 Material	
			产品名称 Product Name	图纸比例 Drawing Scale	A4
			产品编号 Product Code	视图 Project View	(mm)
共 页 第 页			宁波三和壳体公司 NINGBO SANHE ENCLOSURE CORPORATION		中国宁波慈溪 TEL: +8657463226910 FAX: +8657463226900