

剖面 A-A

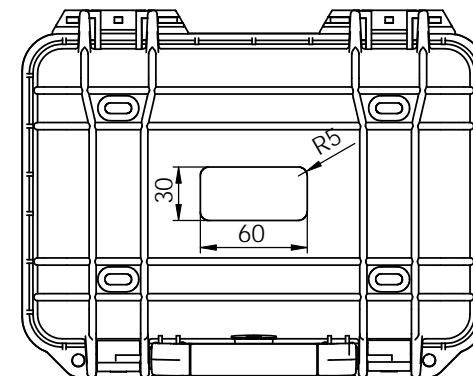

剖面 B-B

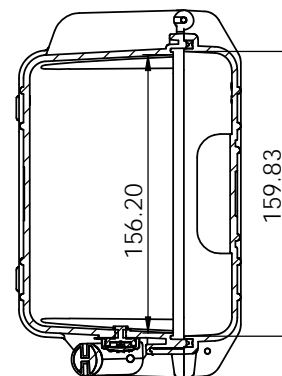
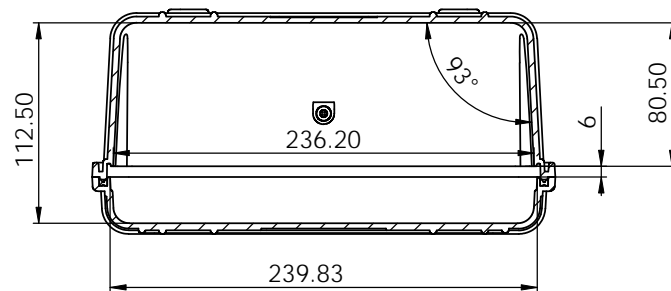

制图 Drawing	审核 Auditing	批准 Confirm	客户名称 Custom Name	材料 Material		
			产品名称 Product Name	图纸比例 Drawing Scale	1:3	A
			产品编号 Product Code	视图 Project View	(mm)	
共 1 页 第 1 页			宁波三和壳体公司 NINGBO SANHE ENCLOSURE CORPORATION		中国·宁波慈溪 TEL: +86(574)63226910 FAX: +86(574)63226900	